

MẶT BẰNG THIẾT BỊ TỈ

LỖ 1:50

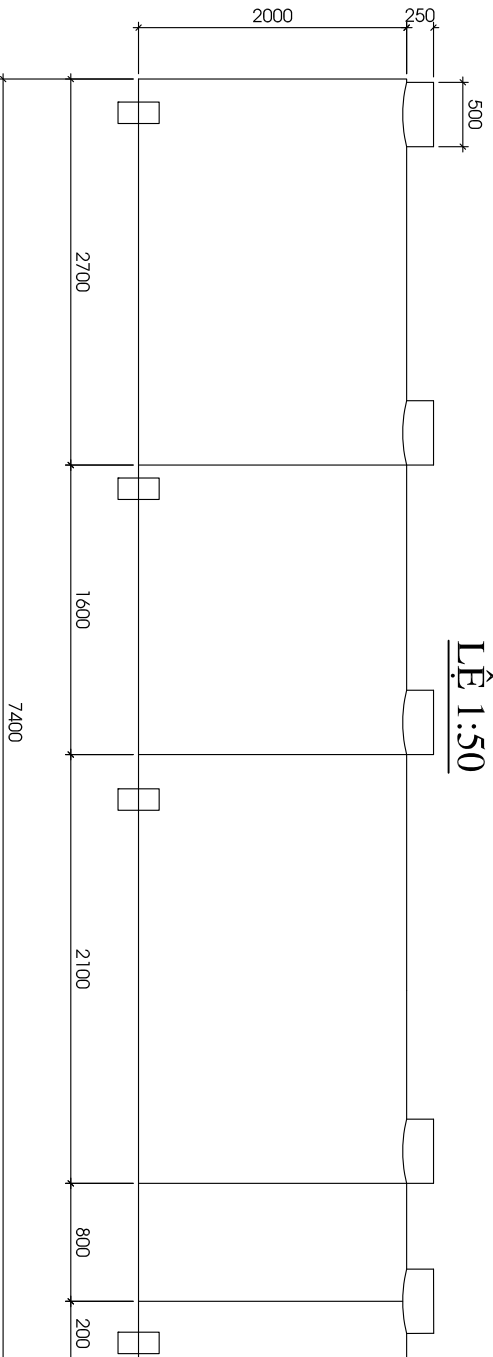

MẶT CẮT A - A TỈ LỆ 1:50

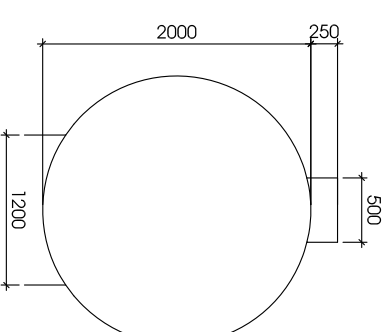
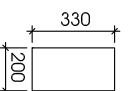
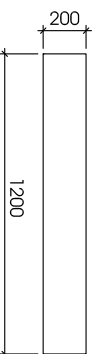
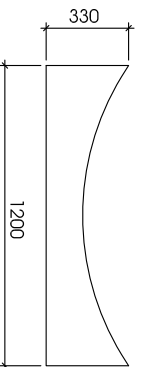

MẶT CẮT B - B TỈ LỆ 1:50

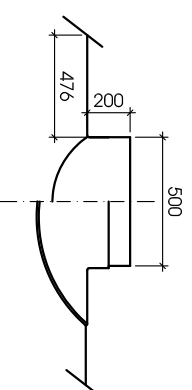
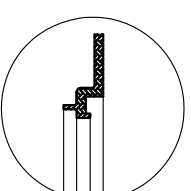
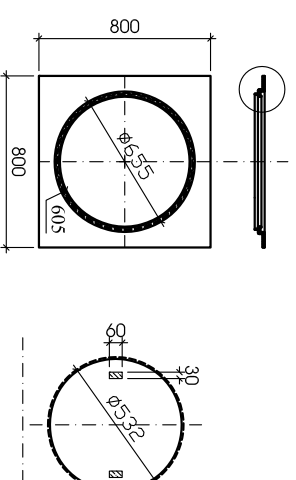

CHI TIẾT NẮP THĂM TỈ LỆ 1:25

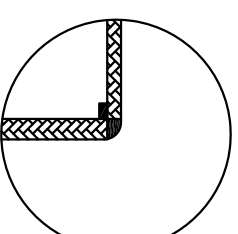

CHI TIẾT 1

CHI TIẾT CHÂN ĐỂ TỈ LỆ 1:25